

Throw Distance Table

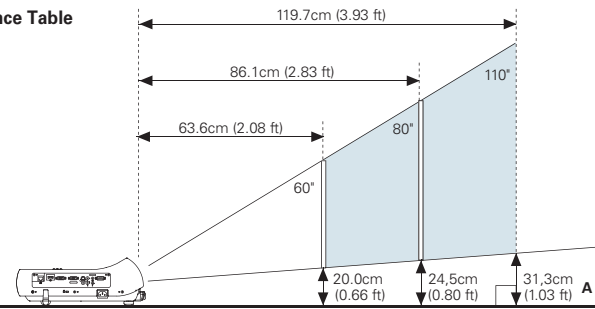

Throw Distance (Aspect ratio 16:10)

| Zoom/Focus | Fixed/manual | | |
|-----------------------------|--------------|--------------------|--|
| Focal length f (mm) | 6.68 | | |
| F value | 1.8 | | |
| Projection light axis H1:H2 | 10:1.68 | | |
| Throw ratio (Indication) | 0.50:1 | | |
| inch | WxH(m) | Distance (cm / ft) | A: Height from the undersurface of the projector to the bottom of the screen (cm / ft) |
| 60 | 1.3x0.8 | 63.6 / 2.08 | 20.0 / 0.66 |
| 70 | 1.5x0.9 | 74.8 / 2.45 | 22.3 / 0.73 |
| 80 | 1.7x1.1 | 86.1 / 2.83 | 24.5 / 0.80 |
| 90 | 1.9x1.2 | 97.3 / 3.19 | 26.8 / 0.88 |
| 100 | 2.2x1.3 | 108.5 / 3.56 | 29.1 / 0.96 |
| 110 | 2.4x1.5 | 119.7 / 3.93 | 31.3 / 1.03 |

* Approximate projection distance are calculated based on lens design specification. Individual lenses may diverge from this figure by up to 5% due to slight variations in lens size and shape.

Terminals



Remote control

External dimensions (unit: mm (inch))

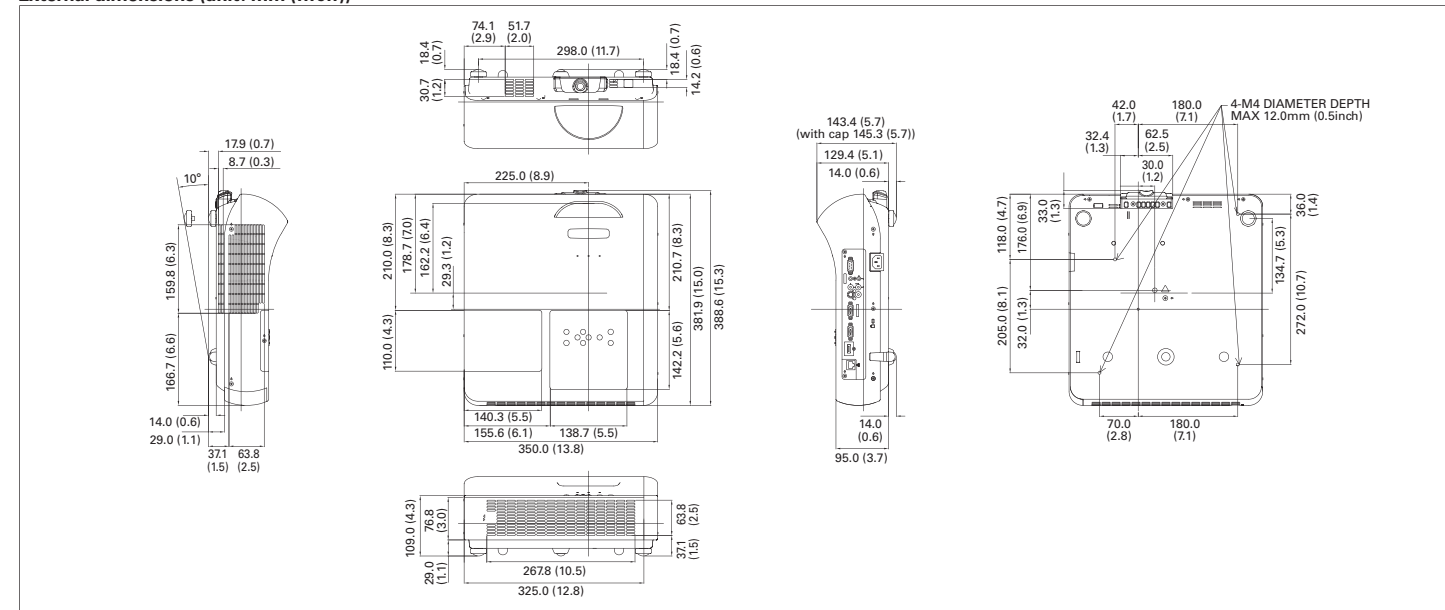

All products manufactured by the Projector Division of SANYO's Digital System Company employ a quality management system that has undergone the inspection and registration process of the ISO 9001 international standard.

SANYO's Digital System Company has received ISO 14001 certification for the environmental management system used in its factory.

Pixelworks ICs are used in this projector

<http://sanyo.com/projector/>

Caution: Please consult the instruction manual to ensure safe and proper operation of the product.

Distributed by:



SANYO Electric Co., Ltd.
Digital System company

© 2010 SANYO Printed in Japan 2010.12 Sl.
SML168

Ultra Short Focus Mobile Projector



PLC-WL2503

Enable Space Saving Projection & Interactive Function,
Powerful Solution for Classroom and Office



WXGA
2500 lm





A wide XGA ultra short-focus mobile projector offering interactive capabilities which enable effective presentation or class

Equipped with an ultra short-focus lens for space saving

A large 80-inch image can be projected from a distance of only 86 cm. The ultra short-focus lens enables projection of a large 80-inch image from a distance of only 86 cm. This permits enjoyable large-screen presentations to be given in a shorter focal distance. In an educational setting, an instructor can show a presentation on the blackboard by simply setting up the projector on an instructor's desk at the front of the classroom. In ceiling-mount situations, the projector can be installed closer to the screen to avoid light shining in the eyes of the presenter.

A Large 80" Image Can Be Projected at a Distance of Only 86 cm

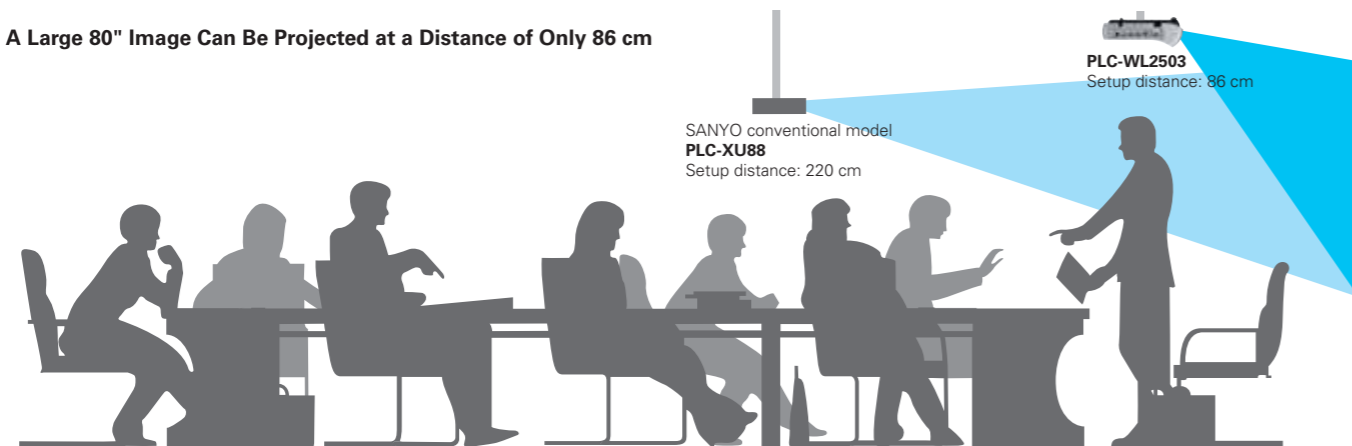

Previous model

- When standing in front of a projector, a presenter is dazzled by the light shining.
- A presenter blocks the light and the shadows on the screen disturb the projection.

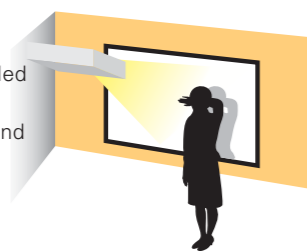

PLC-WL2503

- A presenter is hardly dazzled even when standing in front of a projector.
- The shadows are hardly cast on the screen.

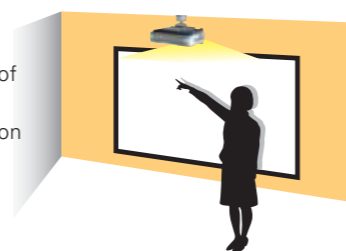

Interactive Function

The Interactive function makes it easy to move between guest rooms, conference rooms and meeting spaces for quick and easy use in a variety of locations. The Interactive function lets you write text, graphics or lines onto projected screen images. You can also save the revised images in JPEG format. A Mouse function also lets you operate the PC right from the screen. That means you can manipulate teaching materials and software that are on the PC, and use a variety of tools. You can give more effective, enjoyable lessons, and more persuasive presentations and meetings.

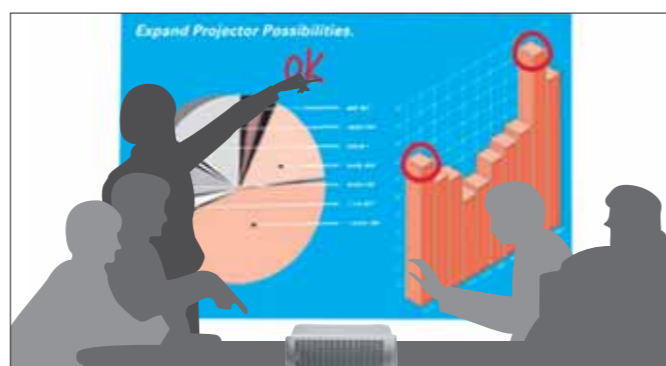

Operating environment

| | OS | Microsoft Windows XP(SP2)/ Vista/Windows 7 |
|---------|-------------|--|
| Windows | CPU | Core Duo or more |
| | Memory | 512MB or more |
| | HDD | 30MB |
| | | |
| Mac | OS | Mac OS X v10.4.11-v10.5 or more |
| | CPU | Intel Processor or Power PC |
| | Memory | 512MB or more |
| | HDD | 10MB or more |
| | Media drive | CD-ROM/ DVD-ROM or four X speed or more |
| | Other | USB 1.1 or later |

Interactive pen(Accessory)



Easy Maintenance

Hybrid filter

Offering long periods of maintenance-free use, without the need for lamp replacement, and filter replacement only after approximately 4,000 hours- Equipped with SANYO's proprietary hybrid filter composed of multiple filter layers. The filter replacement cycle has been extended by a factor of 20 to approximately 4,000 hours*¹ compared to our conventional model*².

*¹ When in Eco mode. Calculated through the company's independent test in reference to the JIS D0207 test method. The filter replacement period is an estimate.
*² SANYO conventional model: PLC-WXL46

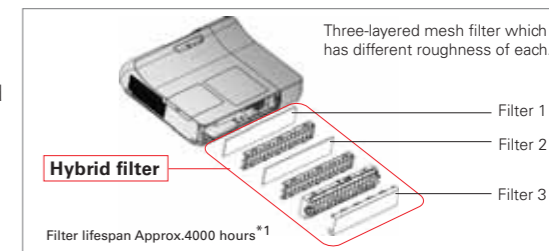

Long-life lamp

The lamp lifespan has been improved by about 30% compared to our conventional model*³, and does not need to be replaced for approximately 4,000 hours*⁴, thereby greatly reducing the inconvenience of product maintenance. The longer lamp lifespan, also makes it more eco-friendly, with a smaller impact on the environment.

*³ SANYO conventional model: PLC-WXL46
*⁴ When in Eco mode. The lamp replacement cycle is an estimate, not guaranteed. It is subject to change according to the use conditions.

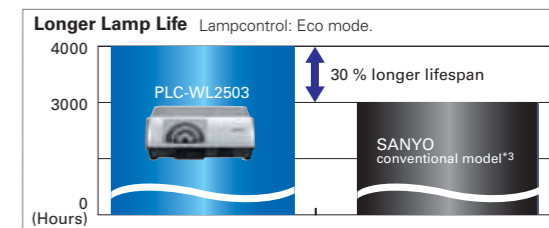

Easier Replacement

Lamp replacement has been simplified to make maintenance easier, Easy removal and replacement of the lamp from the top, Of course the lamp can also be replaced easily even if the projector is ceiling mounted.



Useful Features

16:10 wide-screen aspect ratio LCD panels

The adoption of a high-resolution Wide XGA panel enables projection of 16:10 aspect ratio Wide XGA (1280 x 800 dot) images. Compared to the 4:3 aspect ratio XGA (1024 x 768 dot) format, the size of the screen has been greatly expanded, enabling the display of even more information.

High sound output with a 10-watt speaker

As the first SANYO projector with a high-output 10-watt speaker that produces clearer sound even in large spaces such as conference rooms and classrooms, the PLC-WL2503 can be used for multimedia presentations without the need for any external speakers or extra equipment.

High-brightness projection of 2,500 lumens

Enough brightness and sound volume for high-impact presentations even in larger conference rooms and classrooms. With its 230-watt high-output lamp and newly developed optical engine, the PLC-WL2503 offers high-brightness projection of 2,500 lumens.

HDMI Terminal

The PLC-WL2503 comes equipped with an HDMI (High Definition Multimedia Interface) terminal. It is possible to project beautiful images.

A Wired LAN Network Control function* is included as standard equipment

A centralized management and control system can be easily configured. * This function comes as standard equipment.

Direct Power-off Function

The projector can be turned off by unplugging the cable without pressing the power button.

Silence Design (29 dB, in Eco mode)

The operating noise is hardly noticeable even in quiet settings like conference or AV rooms.

Terminal cover (OPTION: POA-TA-WL2500)

Cables can be stored inside of terminal cover, it makes the appearance neat and organized.



PLC-WL2503 | WXGA | 2500 lm